

# AirGuard™ Operators Manual

Revision 2.08

31 January 2022



---

Table of Contents

<b><i>Introduction</i></b> .....	<b>3</b>
<b><i>Safety Recommendations</i></b> .....	<b>3</b>
<b><i>General Safe Use Considerations</i></b> .....	<b>3</b>
<b><i>AirGuard Approvals</i></b> .....	<b>4</b>
<b><i>AirGuard Specifications</i></b> .....	<b>5</b>
<b><i>Sensor Module Specifications</i></b> .....	<b>6</b>
<b><i>Warranty</i></b> .....	<b>7</b>
<b><i>General Software Interface</i></b> .....	<b>8</b>
<b><i>Menu Function Interface Overview</i></b> .....	<b>9</b>
<b><i>Battery Operation</i></b> .....	<b>10</b>
<b><i>Compressor Pneumatic Connections</i></b> .....	<b>11</b>
<b><i>Start-Up</i></b> .....	<b>14</b>
<b><i>Access Code</i></b> .....	<b>17</b>
<b><i>Bump Test</i></b> .....	<b>19</b>
<b><i>Sensor Menu</i></b> .....	<b>20</b>
<b><i>Calibration</i></b> .....	<b>23</b>
<b><i>Settings Menu</i></b> .....	<b>29</b>
<b><i>Maintenance Menu</i></b> .....	<b>31</b>
<b><i>Data Capture</i></b> .....	<b>32</b>
<b><i>Battery and Power Supply Operation</i></b> .....	<b>35</b>
<b><i>Case Exterior</i></b> .....	<b>36</b>
<b><i>ESD</i></b> .....	<b>36</b>
<b><i>Air Filtration Filters</i></b> .....	<b>36</b>
<b><i>General Filter and Sample Train Parts</i></b> .....	<b>37</b>
<b><i>AirGuard Parts</i></b> .....	<b>38</b>

## Introduction

Thank you for selecting the Bullard AirGuard. The AirGuard is a portable breathing air system which meets NFPA and OSHA requirements. It uses a three-stage filter system which removes contamination and odors in the breathing air stream. The AirGuard reports both Carbon Monoxide and differential dew point values on a visible and externally mounted liquid crystal display. It also has operator warning alarms for flow CFM (cubic foot per minute) and calibration interval reminders. The AirGuard data log records all operational use and calibration events for OSHA (Occupational Safety and Health Administration) compliance reporting.

## Safety Recommendations



### Important Reference Information

**Note** = Important information about use of the instrument.

**Remarque** = Informations importantes sur l'utilisation de l'instrument.

**Caution** = Affects Equipment – If not followed may cause damage to the instrument or sensor.



**Attention** = affecte l'équipement - s'il n'est pas suivi, il peut endommager l'instrument ou le capteur.

**Warning** = Affects personal safety – If not followed may cause bodily injury or death.

**Avertissement** = Affecte sécurité personnelle - non suivi peut causer des blessures corporelles ou la mort.

## General Safe Use Considerations

- AirGuard is an instrument designed for Grade D breathing air compliance. It is important that the operator is trained by qualified personnel to ensure proper use.
- The AirGuard is approved primarily for indoor locations and limited outdoor use.
- Do not use the AirGuard unless you have been trained to operate the instrument and fully understand its implementation as a health and safety device. Inappropriate use can result in severe injury or death.
- Observe Proper Battery Maintenance and use only chargers supplied by BULLARD to avoid battery damage and performance issues.
- Do not recharge AirGuard in a hazardous classified or environmental location.
- Indoor recharging only.

 <b>WARNING</b>	
	
<p>AirGuard does not create Grade D breathing air. Operator must supply a Grade D breathing air source. AirGuard will <u>not</u> increase the oxygen content of air provided. AirGuard will <u>not</u> remove carbon monoxide, carbon dioxide, other toxic gases or fumes.</p> <p>AirGuard is not intended to provide respiratory protection. Do not use AirGuard in oxygen-deficient areas. AirGuard must be operated in the upright position. Thoroughly read the instruction manual and follow all labels. Failure to comply could result in injury or death.</p>	

- Perform a bump check before each use. Adjust the calibration if necessary.
- After airflow is connected, check the 0.01-micron filter for a fault indication. This is displayed by observing the bubble indicator on the top of the middle valve filter assembly when AirGuard is supplied with compressor air.
- Should AirGuard at any time experience severe shock or impact recheck the calibration via a bump check and adjust if necessary.
- Always have a trained and qualified person interpret the results to ensure safe operation.



**Warning!** California Proposition 65 Warning: Cancer and Reproductive Harm  
[www.P65Warning.ca.gov](http://www.P65Warning.ca.gov)

## AirGuard Approvals

Safety Requirements for Electrical Equipment for Measurement, Control, and Laboratory Use  
– Part 1: General Requirements [UL 61010-1:2012 Ed.3 +R:29Apr2016]

Safety Requirements for Electrical Equipment for Measurement, Control, and Laboratory Use  
– Part 1: General Requirements [CSA C22.2#61010-1-12:2012 Ed.3 +U2]

Manufactured by ENMET LLC, 680 Fairfield Ct. Ann Arbor, MI 48108  
for Bullard, 1898 Safety Way, Cynthiana, KY 41031  
Phone: 859.234.6611 [www.bullard.com](http://www.bullard.com)

---

**Model No: AGP**  
Input Voltage / Tension d'entrée: 13.8  $\equiv$  0.8A

	Caution: Use Only Approved Battery Charger. Refer Servicing to Qualified Service Technician	Attention: utilisez uniquement un Chargeur de Batterie approuvé. Se reporter à Entretien Technicien qualifié
---	---	--

 Conforms to UL STD. 61010-1  
Certified to CSA STD. C22.2 # 61010-1

Serial Number:

Part Number:

Made in the USA 

## AirGuard Specifications

**Enclosure:**

Polypropylene case

**No. of Breathing Air Lines:**

1, 2, 4 or 8

**Size /Weight:**

1-line: 19.2 lbs, 18.7" x 13.2" x 7"

2-line: 24.6 lbs, 22.6" x 15.8" x 7.6"

4-line: 31.6 lbs, 26.4" x 19.6" x 9"

8-line: 34 lbs, 26.4" x 19.6" x 9"

**Operating Environment Conditions:**

Temperature - (32°F to 104°F) (0°C to +40°C)

Ambient Humidity - (10% to 95% RH, non-condensing)

Altitude Sea Level +400M

**Storage Environment Conditions:**

Temperature - (5°F to 140°F or -15°C to +60°C)

Altitude Sea Level +1,200M

**Storage Ambient Humidity:**

10% to 95% RH, non-condensing

**Power Supply:**

100-260 VAC 50/60 Hz (< 10 Watts average) to run unit and/or charge battery.

**Internal Battery:**

12V / 7Ah rechargeable lead-acid, removable

**Battery Life:**

10 hours (typical)

**Local Alarm Signal:**

Color display background and high intensity audible (90 dB) horn

**Remote Alarm Signal:**

Remote alarm jack with 12VDC output

**Pollution Degree Rating:**

3

**Water Resistance:**

IP42

**Agency Approvals:**

UL 61010 (US & Canada)

**Warranty:**

2-years parts & labor (excluding instrument calibration and expendable parts such as calibration gas, filters and batteries)



---

## Sensor Module Specifications

### Sensor Types:

Carbon Monoxide - (0 to 50 ppm)

Dew Point - (-20°F to ambient)

Flow Rate - (0 to 100 CFM)

### Sensor Accuracy:

Carbon Monoxide:  $\pm 5\%$  @ 10 ppm

Dew Point:  $\pm 2^\circ\text{F}$  @ 50°F dewpoint

### Air Flow Alarm Pt.:

< 5CFM  $\pm 1$  CFM

### Air Filter Train Filters (3):

(1) 5.0-micron filter, (2) 0.01-micron filter and (3) carbon absorber filter

### Sensor response time:

< 60 seconds

### Display:

Backlit, 7" diagonal color display

### Keypad:

3-button, weatherproof w/ tactile feedback

### Data Logging:

2 points per minute

### Data Storage Medium:

USB memory stick

### Calibration:

Span and Zero, Recommended Monthly, 60 Days Yellow Alert Warning, 90 Days Red Alarm Warning

## Warranty

BULLARD warrants new AirGuard to be free from defects in quality and material under regular use for two years from the date of shipment from BULLARD. The warranty covers both parts and labor, excluding instrument calibration and expendable parts such as calibration gas, filters, batteries, etc.

Equipment believed to be defective should be returned to BULLARD within the warranty period (transportation prepaid) for inspection. If the evaluation by BULLARD confirms that the product is faulty, it will be repaired or replaced at no charge, within the stated limitations, and returned prepaid to any location in the United States by the most economical means, e.g., Surface UPS/FedEx Ground. If a faster level of transportation is requested during the warranty period, the customer is responsible for the difference between the most economical means and the desirable mode.

BULLARD shall not be liable for any loss or damage caused by the improper use or abuse of the product. The purchaser indemnifies and saves harmless the company concerning any loss or damages that may arise through the application by the purchaser or others of this equipment. This warranty is expressly given in place of all other warranties, either expressed or implied, including that of merchantability, and all other obligations or liabilities of BULLARD which may arise in connection with this equipment. BULLARD neither assumes nor authorizes any representative or other persons any responsibility or liability other than that which is set forth herein.

When returning an instrument to the factory for service be sure to include the following information.

1. A purchase order, return address, and contact information will assist in the expedient repair and return of your unit.
2. Include any specific instructions.
3. For warranty service, include date of purchase.

If you require an estimate, please contact BULLARD AirGuard support at 877-285-5273.

## General Software Interface

AirGuard uses a computer control menu interface which communicates using a Liquid Crystal Display (LCD). Three buttons control this interface. These buttons toggle the menu function selection, allow the adjustment of numeric values, and enter commands.

This three-button interface is located directly under the LCD. The buttons are color-coded, (left) red cursor up, (middle) green enter and (right) orange cursor down. Additionally, the up-down buttons have a droplet point for direction to assist function direction.

-  Power On/Off
-  Green Enter Function
-  Orange Cursor Down Selection
-  Red Cursor Up Selection

The main menu has three menu icons that allow access to menu functions and operational changes. From the primary display, these icons are accessed by using the up/down buttons. The active icon selection has a black border while the other icons will be grey. The default position is located on the check icon. Toggling the buttons (orange button) down or (red button) up will change the icon selected position. Upon selection of the desired function, press the middle green enter button to enter the function.

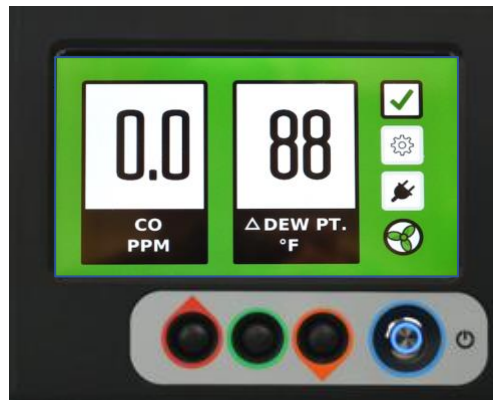



## Menu Function Interface Overview

Upon powering on, the AirGuard will display a warmup screen and then “AirGuard Status” screen which communicates the status of 5 monitored functions.

- 1. CO Concentration Alarm
- 2. Calibration Interval Day Count Down
- 3. CFM Flow Alarm
- 4. Dew Point Sensor Operation
- 5. Air Flow to the CO Sensor

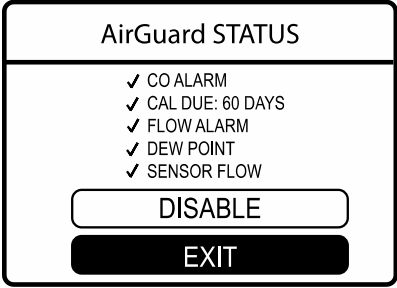

This icon has three status functions as defined below.

- 1. Green Check = System Operation Satisfactory
- 2. Yellow Check = System Caution or Warning to which user attention is required.
- 3. Red “X” = System Fault - AirGuard requires immediate calibration or service and must not be used until the issue reported is resolved.

Should the status of the AirGuard change during operation, the AirGuard will change the green check symbol along with the display background. When the check symbol changes color, the operator can press the enter button to display the AirGuard Status screen which will show the warning or fault encountered.

The alarms can be disabled by selecting the disable function during an activation event.

To get to the main display, the operator must toggle to the exit function to display the main operational screen as illustrated below.

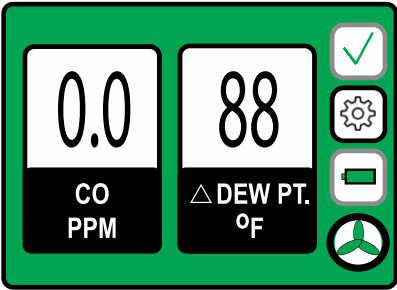

To power down the AirGuard, press the power button, the shutting down screen will appear, the LCD will turn off and finally the power button will go dark.

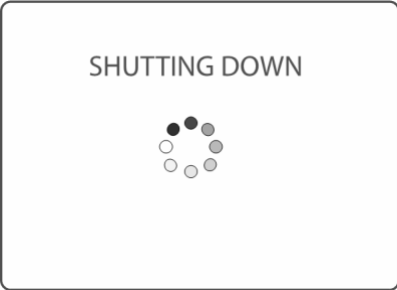

## Battery Operation

The AirGuard is a battery-operated portable instrument and should be fully charged before use.

To charge the AirGuard, you must connect the charge connector cable to the charging inlet located on the lower right side of the instrument. Insert the 2.5mm Ault connector into the female receptacle, secure the connector by screwing it together, clockwise and then power the charger by connecting to main or wall power 100 to 240VAc power.



The battery can power the AirGuard for 16 hours of operation.

The AirGuard will indicate a low battery in two ways, one through the main display battery icon turning red. The other is a screen warning that will appear on the LCD.

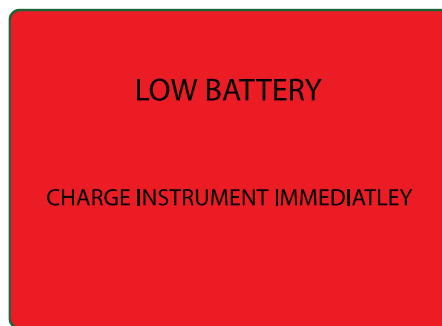

If the charger is not connected the LCD will power down to conserve remaining battery power.

## Compressor Pneumatic Connections

Prepare to connect the air supply from the compressor to the AirGuard inlet located on the left side of the instrument.



Caution! 150 pounds is the maximum inlet pressure

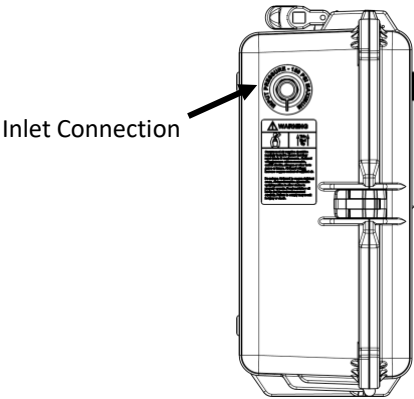

Attach the pneumatic hose from the compressor to the AirGuard.

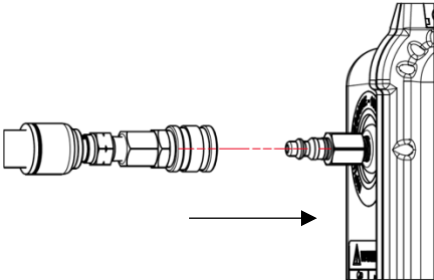

To connect to the AirGuard inlet pull the outside ribbed ring away from the end of the compressor hose and push the connector into the receptacle port. Release the ribbed connector to complete the connection. Make sure the connection is secure.

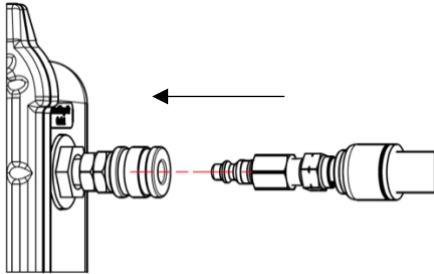

Follow the same process in reverse to disconnect the hose.

The following chart illustrates the CFM delivered at different inlet pressures.

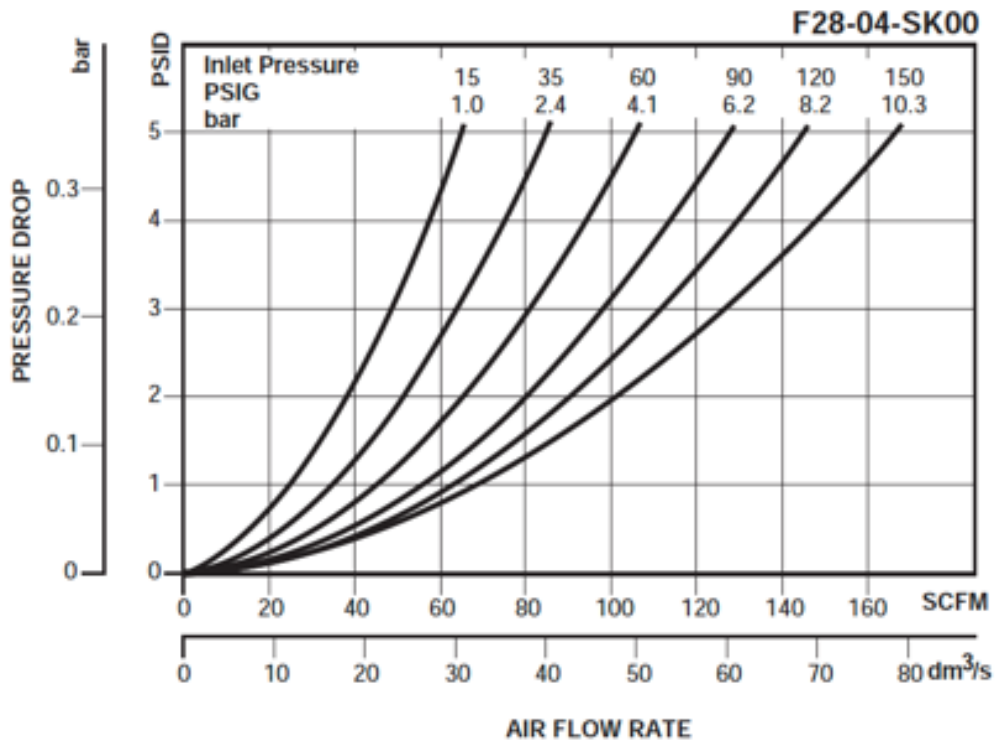



Warning! Maximum Supply inlet pressure cannot exceed 150psi

Review the personal protective equipment instructions to be used with AirGuard. You need to know the pressure setting required for the correct flow.

Open the enclosure and adjust the delivery pressure by turning the regulator adjustment to the desired pressure to deliver required SCFM as per the NIOSH approved respirator being used. Clockwise increases the pressure value.

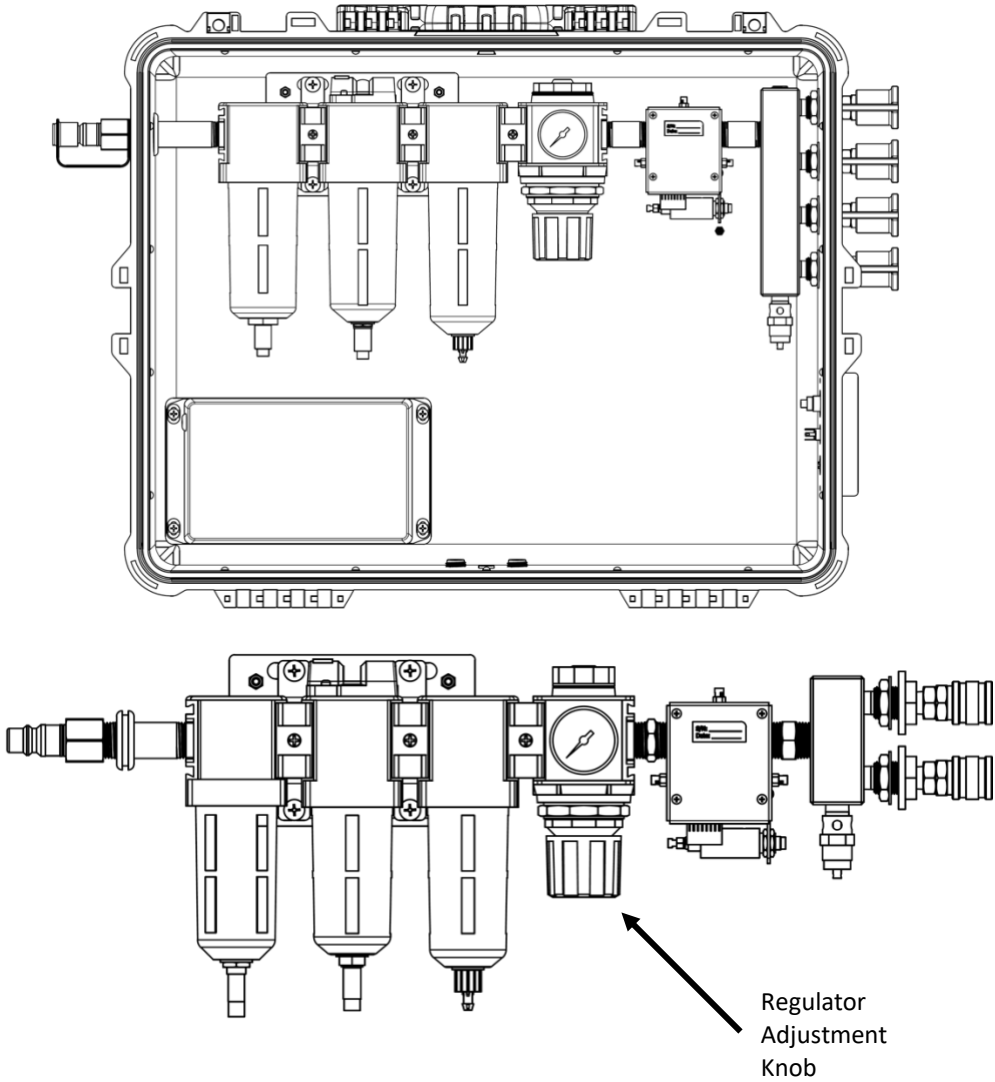

## Start-Up

To turn on the AirGuard, you must press the power on button.

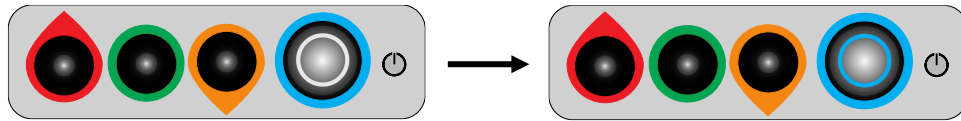

Once pressed, it will illuminate light blue.

During this time the main LCD will activate in  $\approx$  30 seconds, and the main warm-up in progress screen will display.



After warm-up functions are finished the AirGuard status screen will display a report of 5 key metrics of operation.

1. CO Alarm
2. Calibration Due
3. Flow Alarm
4. Differential Dew Point
5. Sensor Flow

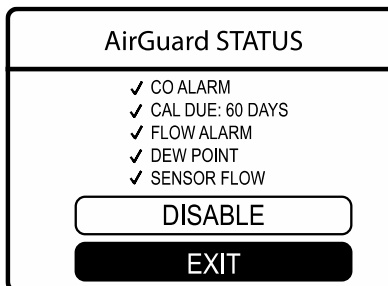

All parameters with a green "check" are satisfactory.

A red "X" will report an unsatisfactory operational status which will need to be corrected or cleared before use. A yellow "check mark" will appear if there is a caution or warning condition that may require action.



Warning! Below is an example of an AirGuard Status Screen fault message due to no compressor flow.

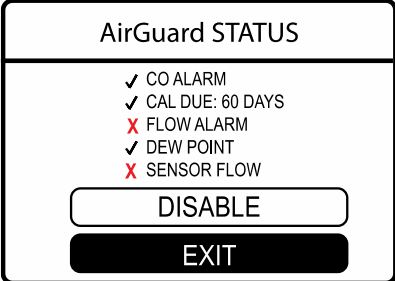

After toggling to the exit function, the main operation screen will appear. Under this condition the main screen will display a dash (-) in place of the carbon monoxide reading. This is a safety measure to ensure the AirGuard is operating under the correct conditions of compressor flow

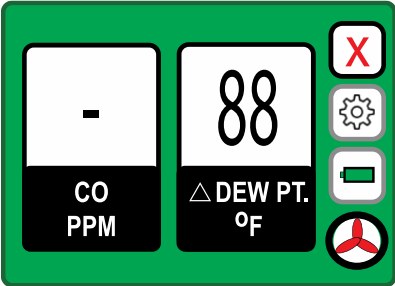

Once compressor airflow is established the carbon monoxide value will appear.

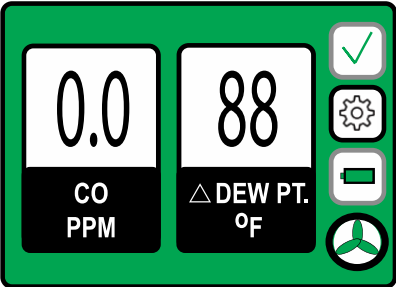

Upon each power up the operator must acknowledge the "AirGuard Status" report before the instrument is ready for operation. To begin active operation, the user must toggle down to the exit function and press enter.

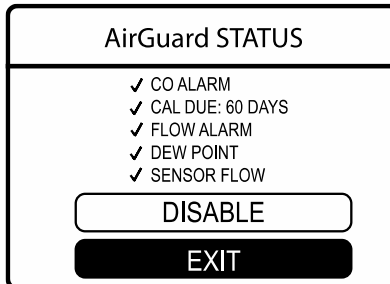

Next, the main screen will appear indicating the current CO concentration (ppm) and the differential dew point value in degrees Fahrenheit when connected to compressed air supply. To change the unit to centigrade, refer to page 22.

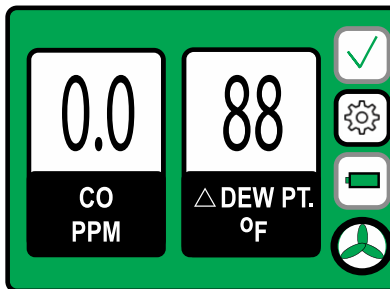

Upon display of this screen, the AirGuard is now in normal operational status.



Access Code

To modify the AirGuard functions you must enter an access code.

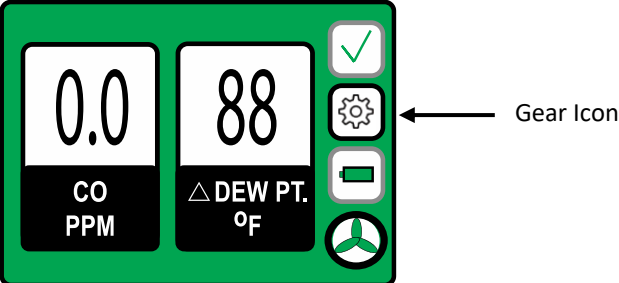

Toggle to the gear icon by using the down or orange code button. The gear icon outline will appear black and press enter (green button).

The Access Code Screen will appear.

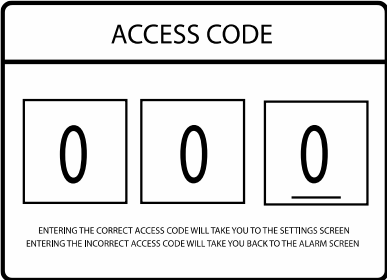

Enter the assigned access code, the factory pre-set is 2 - 7 - 0.

Entering the correct code will take you to the "Main Menu Settings" screen, if an incorrect code is entered the main alarm screen will appear.

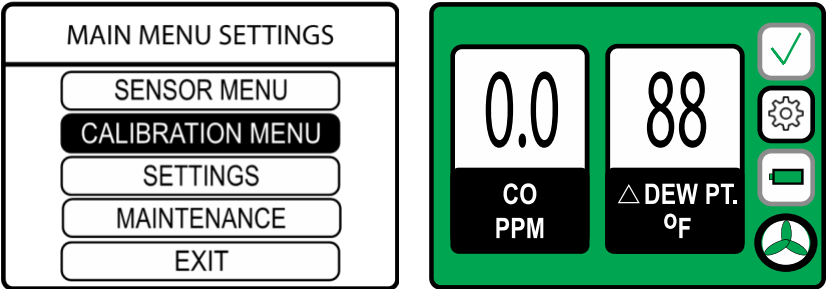

When powered in a no flow condition, the AirGuard will report a system fail “X” and a red fan icon. Additionally, the system status screen will indicate a flow alarm and sensor flow failures. Once flow is re-established from the compressor the system status will return to a green check and fan will turn green. The AirGuard system status screen will display updated information clearing the flow alarm and sensor flow failures to green checks.

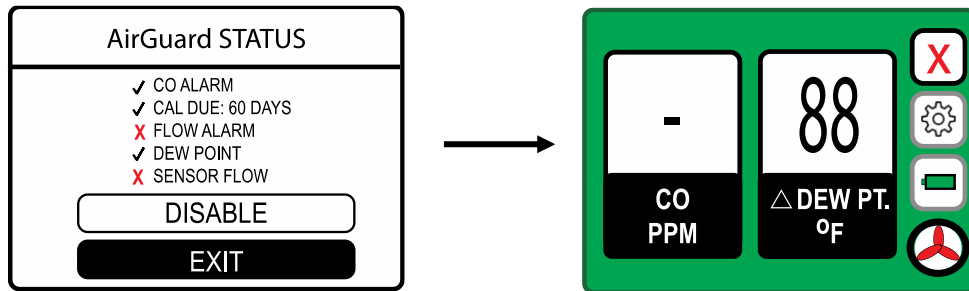

Once the gas flow is started, it will take about 4 minutes for the LCD to report the measured gas concentration. The range of acceptance on a 10 ppm CO standard is 9 ppm to 11 ppm. If the gas concentration is outside of these values we recommend a complete two-step calibration be performed. Refer to page 23 for step by step calibration instructions.

## Bump Test

It is recommended that the AirGuard is bump checked before use to ensure proper response to a known calibration standard. Should the reported test values from the bump check not meet the calibration standard value,  $\pm 10\%$  of the reference value, it should be recalibrated.

BULLARD provides a calibration kit for the AirGuard with all the components to complete this test.  
(Part Number: AGDCK)



**Warning!** To perform a bump check, the AirGuard must be disconnected from the compressor air supply.

Calibration cylinder must be connected to a pre-determined or fixed flow regulator assembly, with a male quick connect fitting and tubing attached to the regulator.

The calibration cylinder assembly tubing is then attached to the female calibration connection located on the right-hand side of the instrument and the cylinder is turned on to initiate gas flow.

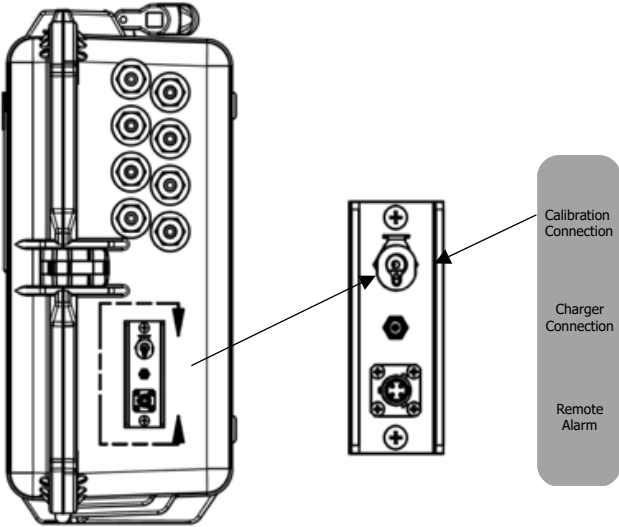

## Sensor Menu

The sensor menu allows the operator to adjust function parameters. This includes CFM (flow) alarm and warning values as well as the audio alarm horn.

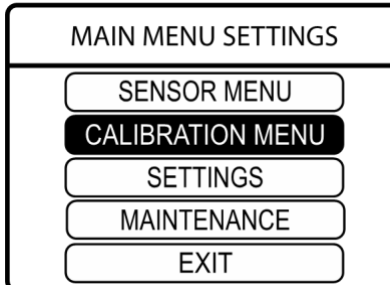

The Sensor Settings menu allows adjustment of Air Guard set points such as alarm values, CFM flow value and delta dew point units.

For the adjustment of number values, the active box containing the number will have a bold border indicating it is active. To adjust the values, you must use the up and down buttons below the display. You will move to the next value entry by pressing the enter button or going back to the previous menu.

1. CO (Carbon Monoxide) displays the preset alarm values. These values are user adjustable. The maximum high-level alarm setting is 10ppm. A value setting higher than 10ppm cannot be entered as per OSHA requirements. A CO warning alarm (yellow alert) can be set to any value, but cannot be set to the alarm level value.

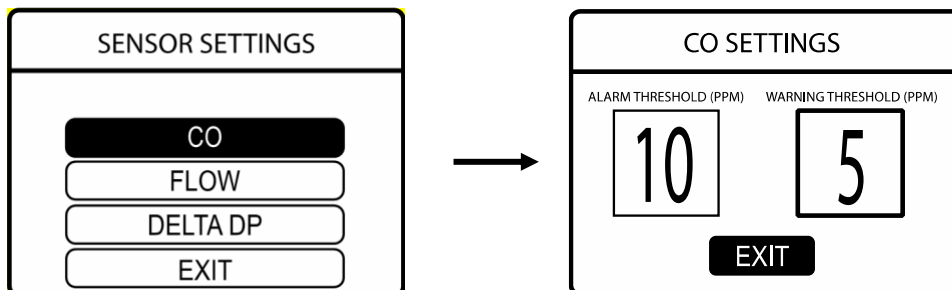

2. Flow settings adjust both the horn and visual alarms.

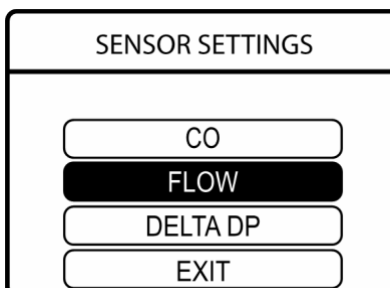

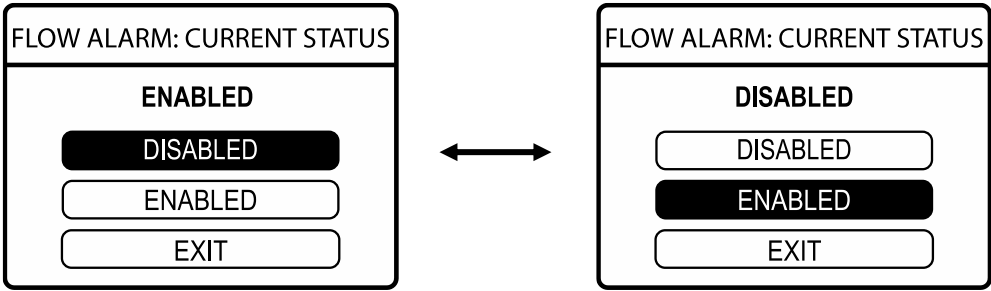
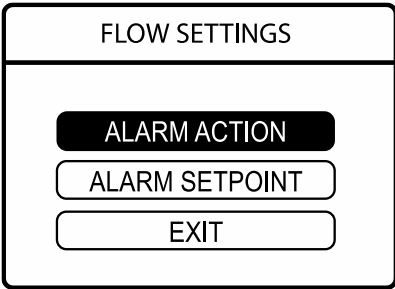

Warning! The flow alarm feature is active only upon flow from the compressor and then loss of flow. This is done to avoid audible alarm horn sounding if powered up prior to compressor connection.

To adjust the CFM alarm value toggle to alarm setpoint and adjust values between 2 and 9 CFM.

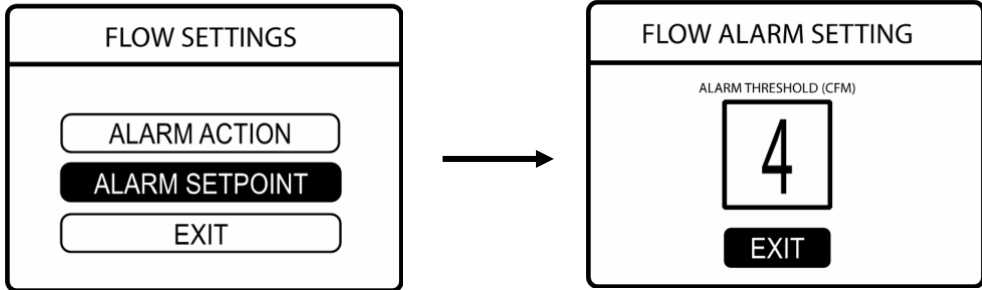

3. Dew Point setting is factory pre-set to alarm as follows:

- Yellow Alert/Warning at 15°F
- Red Alarm at 10°F

The AirGuard can report the delta dew point in either Fahrenheit or Celsius.

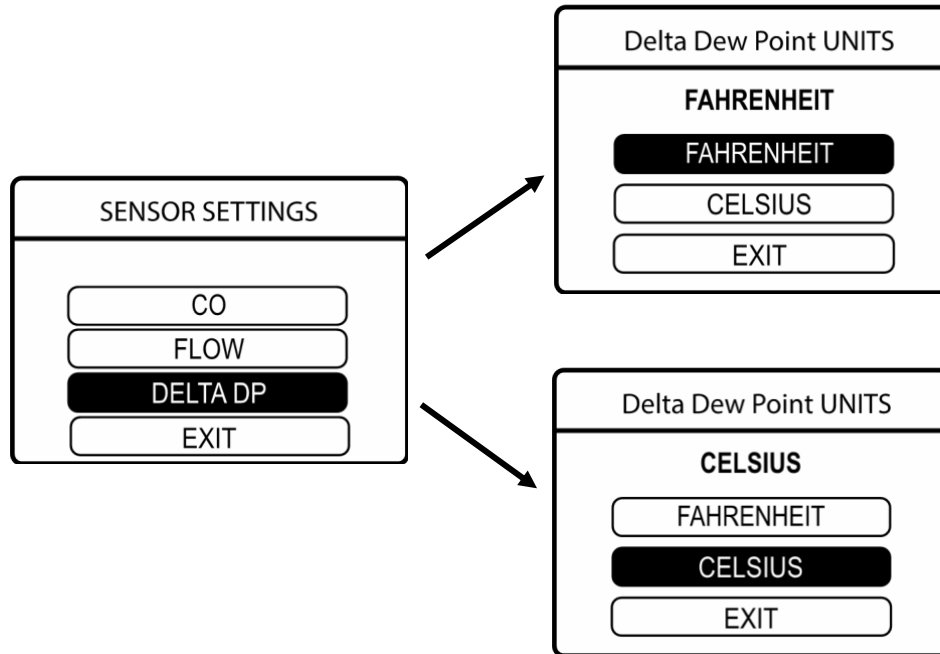

## Calibration

BULLARD provides a calibration kit for the AirGuard with all the components to complete this test. (Part Number: 03414-005)

From the main screen display and using the keypad, toggle the up or down arrow buttons to activate the gear icon. Correct activation of the gear icon is observed by the grey outline becoming black.

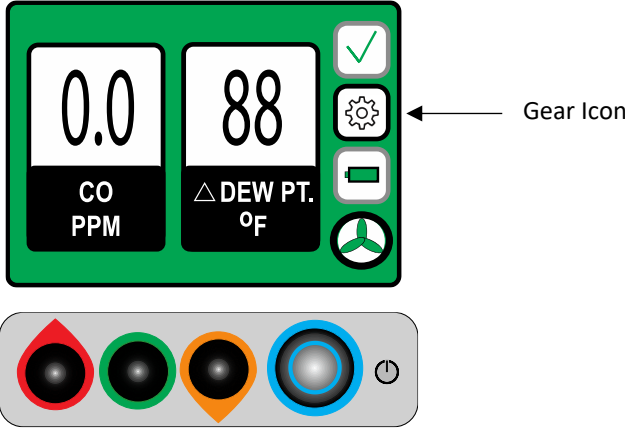

Press the middle or green button on the keypad to enter the function menu.



**Warning !** Make sure the compressor is disconnected from the AirGuard.

Toggle (Up or Down) to Calibration Menu, select enter (green button).

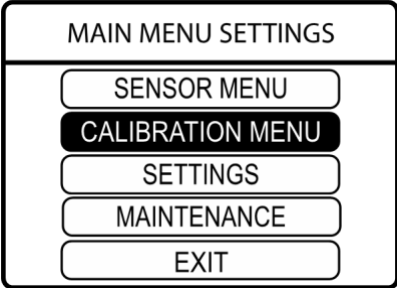

Enter the CO Function

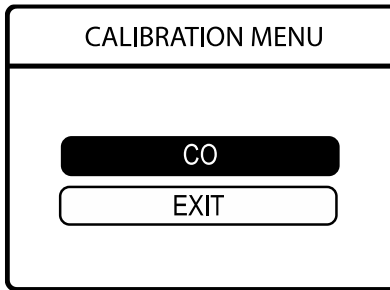

Enter the Zero Function

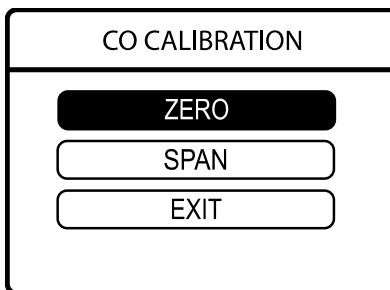

Prepare the Zero Gas (20.9% Oxygen) cylinder.

Attach the regulator to the Zero Air cylinder.

The AirGuard will display a warning screen to make sure the compressor is disconnected.

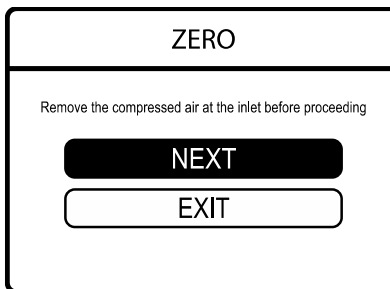

Upon selecting "NEXT" the AirGuard will display a picture of the instrument and the gas connection location.

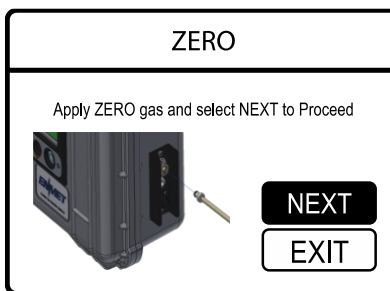



Connect the regulator to the calibration port on the side of the AirGuard.

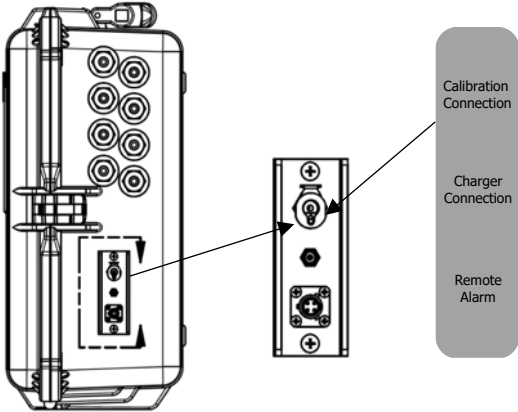

Open the gas regulator fully by turning the on/off knob two turns counter clockwise.

Upon selecting the “NEXT” the AirGuard will display a “Zero in Progress” display with a timer which counts down the time remaining in the zero function.

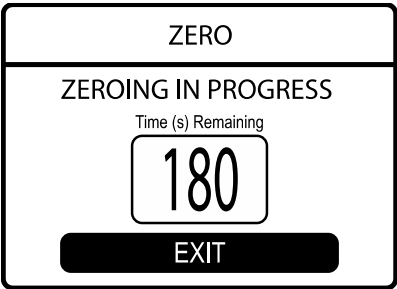

Upon completion, the AirGuard will display a screen indicating the sensor voltage (mV) and also report sensor flow, main flow, and results. A green check indicates a successful event.

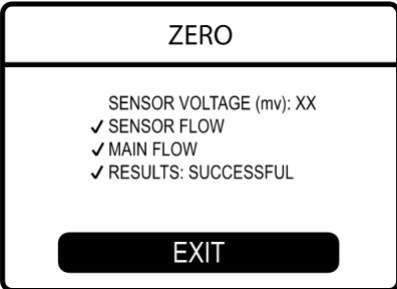

Sensor voltage (mv), Zero gas reading can vary between 25 mV to 100mV.

If a zero is unsuccessful the AirGuard will display a fault screen.

Below is an example of low or no flow associated with the calibration regulator flow, on/off position

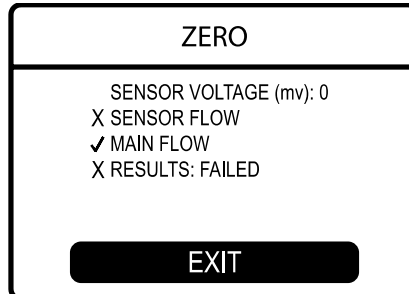

Enter the Span Function

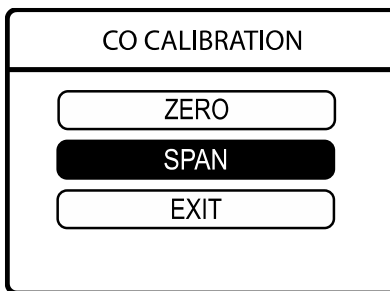

Prepare the Span Gas (10 ppm Carbon Monoxide) cylinder.

Attach the regulator to the Calibration Span cylinder.

Connect the regulator to the calibration port on the side of the AirGuard.

Open the gas regulator fully by turning the on/off knob two turns counter clockwise.

The AirGuard will display a warning screen to make sure the compressor is disconnected.

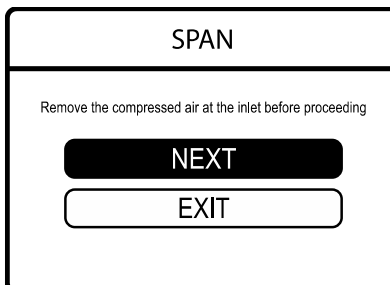

Upon selecting “NEXT” AirGuard will display a picture of the instrument and the gas connection location.

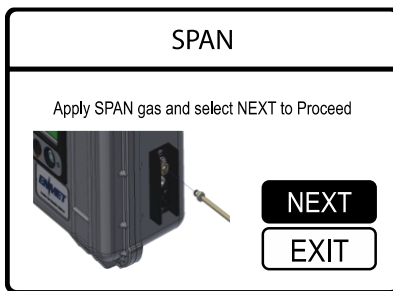

Upon selecting the “NEXT”, AirGuard will display a “Span in Progress” display with a timer which counts down the time remaining in the span function.

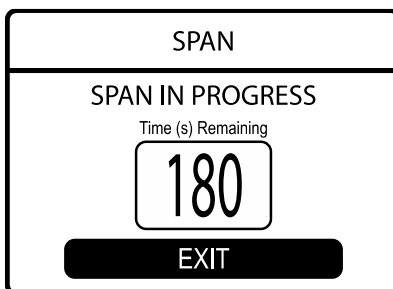

Upon completion, the AirGuard will display a screen indicating the sensor voltage (mV) and report sensor flow, main flow and results. A green check indicates successful calibration event.

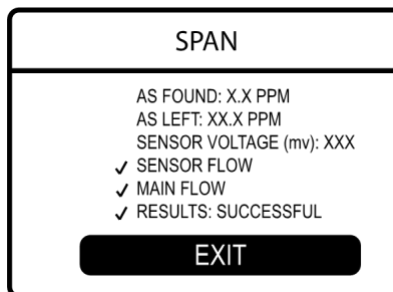

Sensor voltage (mv), (Calibration Gas) reading can vary between 200 mV to 350mV.

If a span is unsuccessful the AirGuard will display a fault screen. The fault screen will appear if gas flow is not present or the signal from the sensor is unsatisfactory due to sensor age.

Below is an example of the fail screen due to low flow and resulting sensor response.

SPAN
AS FOUND: X.X PPM AS LEFT: XX.X PPM SENSOR VOLTAGE (mv): XXX ✓ SENSOR FLOW ✓ MAIN FLOW X RESULTS: FAILED
<b>EXIT</b>

SPAN
Connect the compressed air before proceeding
<b>EXIT</b>

Settings Menu

The settings menu allows you to set the time and date as well as the horn function.

It is important to have the correct time and date so the datalog captures the correct information.

Note: The clock will not update for daylight savings time.

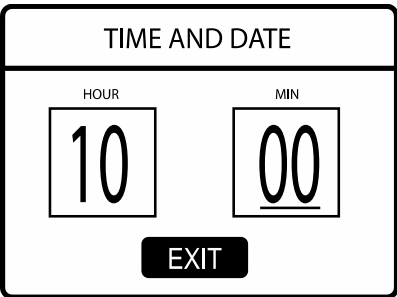
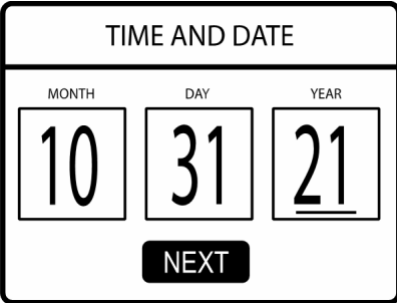
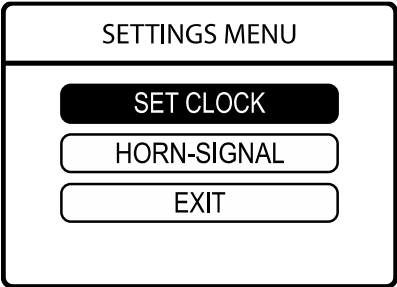
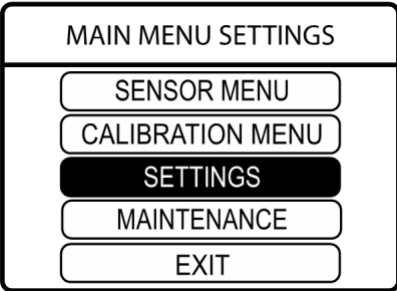

The horn signal either enables or disables the audio horn. When the AirGuard is repowered, these settings will resume enabled which is the default condition.

It is recommended that the horn be enabled to ensure alerts and safe operation.

SETTINGS MENU
SET CLOCK
<b>HORN-SIGNAL</b>
EXIT

HORN-SIGNAL
CURRENT STATUS: <b>ENABLED</b>
<b>DISABLE</b>
ENABLE
EXIT

HORN-SIGNAL
CURRENT STATUS: <b>DISABLED</b>
DISABLE
<b>ENABLE</b>
EXIT

Maintenance Menu

AirGuard has several maintenance menus that record and store important information, such as filter replacement installation date, sensor installation date and total run time.

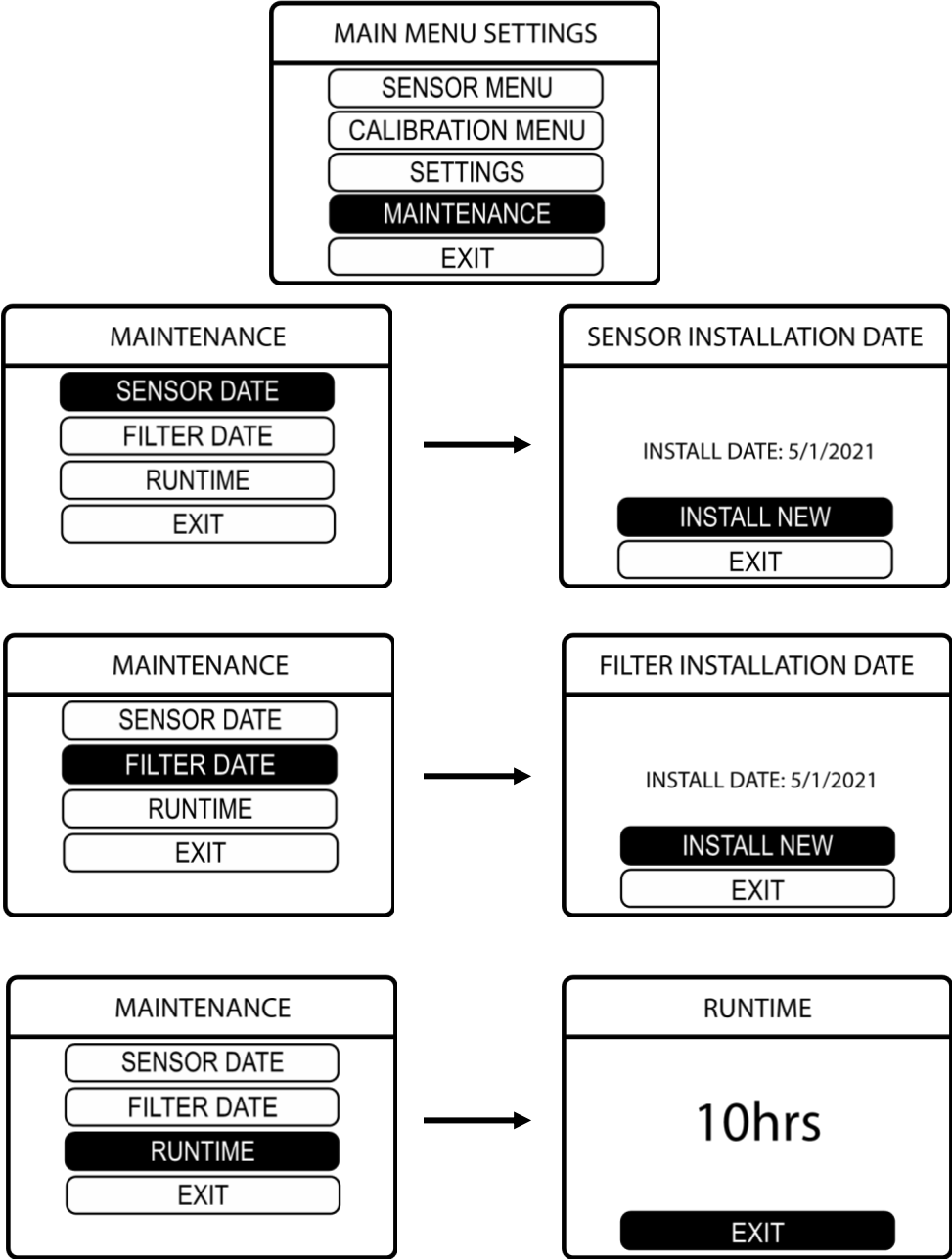

## Data Capture

AirGuard uses a removable USB which is located on the metal enclosure surrounding the microprocessor.

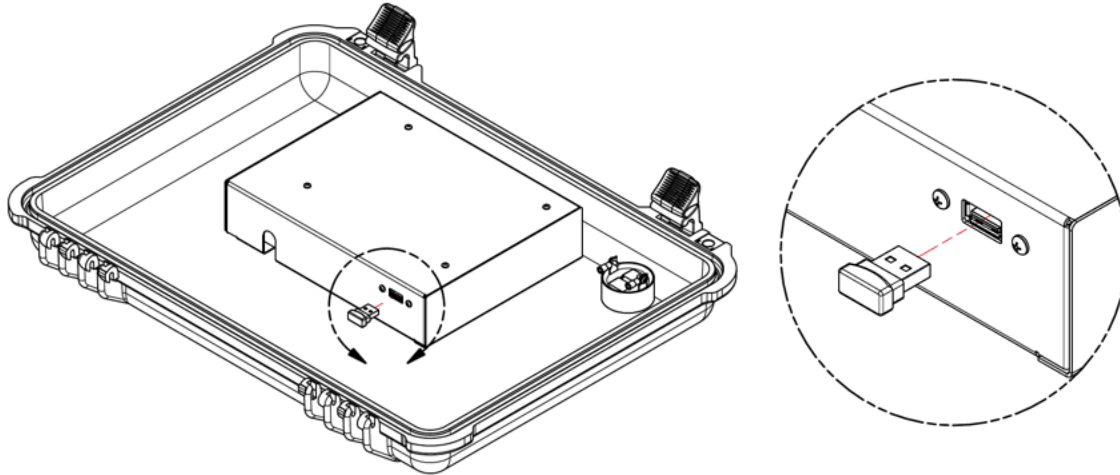

The USB can be read by either a MS Windows or Mac PC.

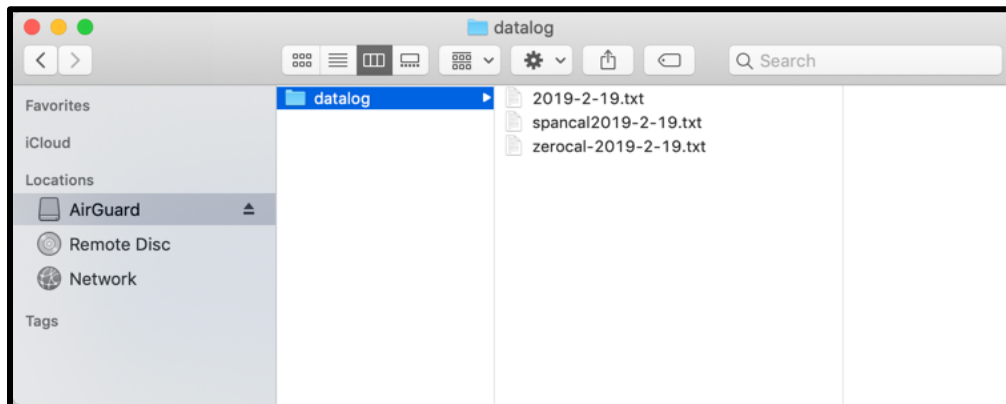

The full data log file is named as 2019-2-19.txt file and can be imported into a spreadsheet (Excel).



Upon opening in Excel, the software will inquire about import format using text import wizard. The arrow indicated the correct radio icon selection.

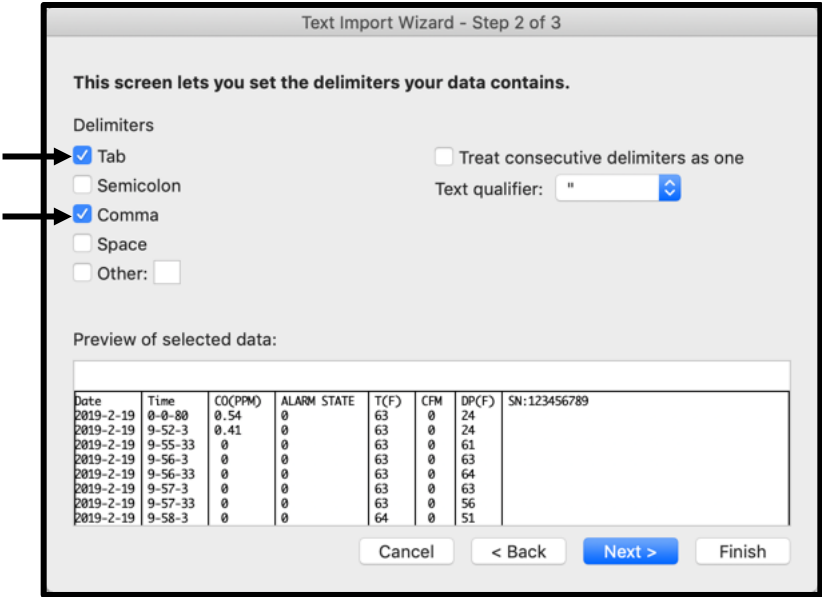
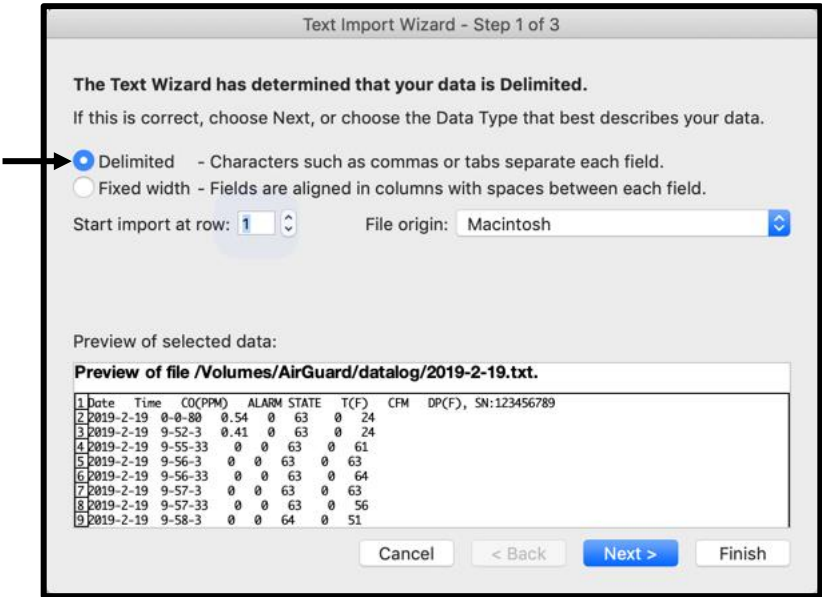

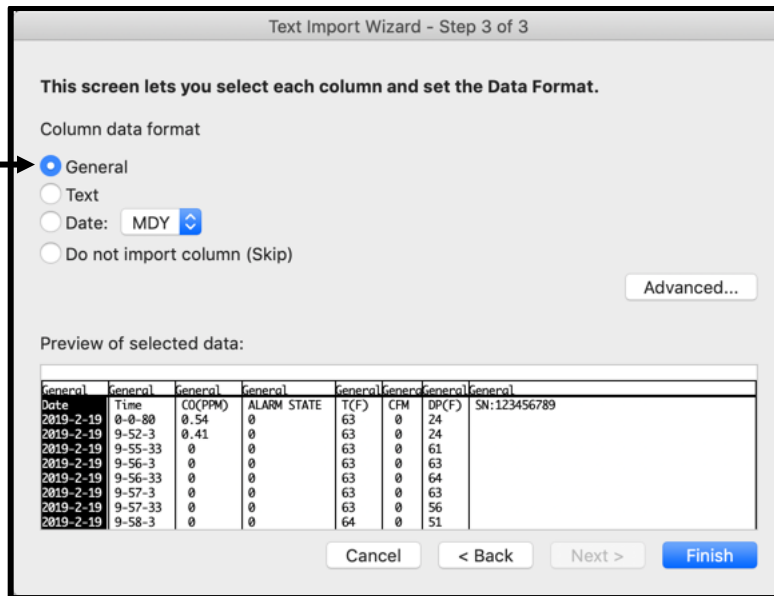

After parameter selection the log will open in Excel for further data and plotting analysis.

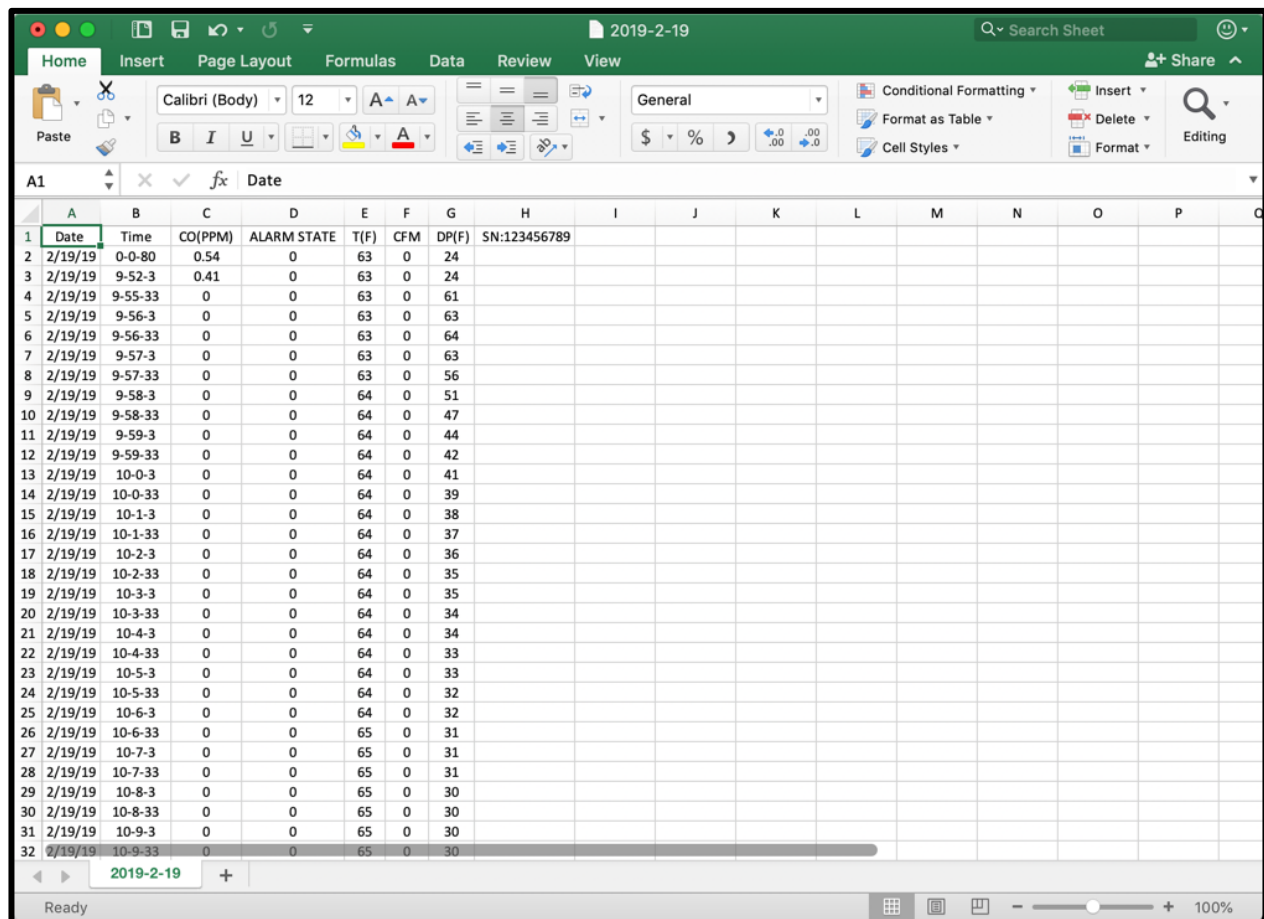

## Battery and Power Supply Operation

The AirGuard is battery powered. The maximum expected battery operation is 16 hours when operating from a full charge. The relative charge of the battery is displayed on the main display and this can be queried as to status by the user on demand. The battery charger has a LED that reports the following, Red LED indicates charging and Green LED indicated fully charged.

The lead acid battery is expected to last one year or approximately 200 complete charge cycles.



**Warning!** Charge the battery every 90 days.

The AirGuard can also be operated by using the 12VDC power supply for continuous duty beyond the limit of the battery supply. The main screen icon will change to a plug symbol indicating the power supply is operating. When the 12VDC power supply is being used to operate AirGuard it will also charge the battery.

To recharge the battery the connector must be fully inserted and then screwed into the charge port until tight.

### **AirGuard - Battery Malfunction**

If the AirGuard will not power up it is due to a discharged battery. If this occurs, connect the battery charger to the AirGuard. The charger LED should immediately turn red, indicating charging. If the LED remains green the battery must be replaced. To replace the battery assembly order part number AGBBAT.

You have the option of operating the AirGuard using just the battery charger. To allow the AirGuard to function in this mode you must disconnect the battery. Disconnect the charger from the AirGuard charging input. Open the AirGuard enclosure and disconnect the white AMP connector (2 pin) illustrated on the picture below. Once the charger is re-connected and you press the power button the AirGuard will power up. The battery charger LED will light red. When you turn off the AirGuard the battery charger LED will turn off.

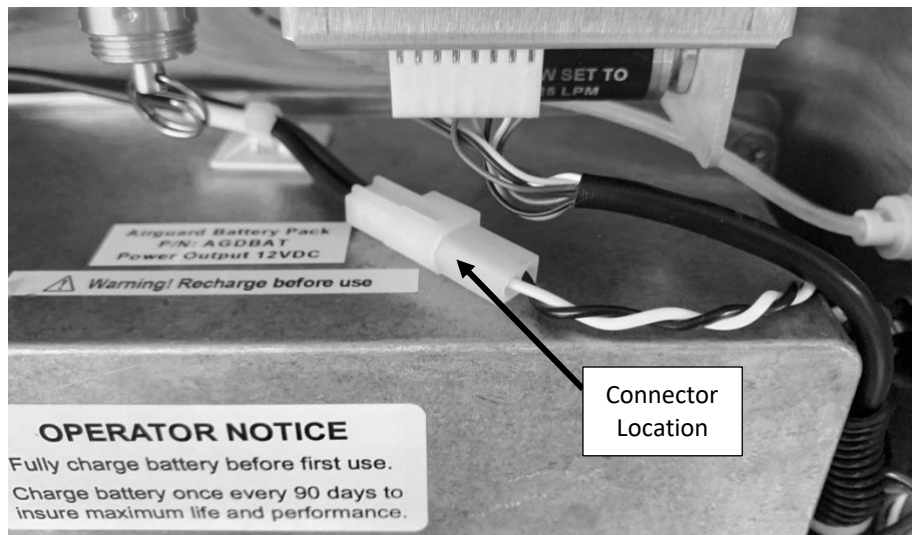

## AirGuard Maintenance

### Case Exterior

When dirty or dusty wipe down with water (wet cloth) and dry with a soft cloth.

### ESD

The device contains electrostatically sensitive components. Do not open or repair the device without using appropriate electrostatic discharge (ESD) protection. The warranty does not cover damage caused by electrostatic discharges.

### Air Filtration Filters



**Warning!** Replace all three filter elements when the coalescing filter indicator is red.

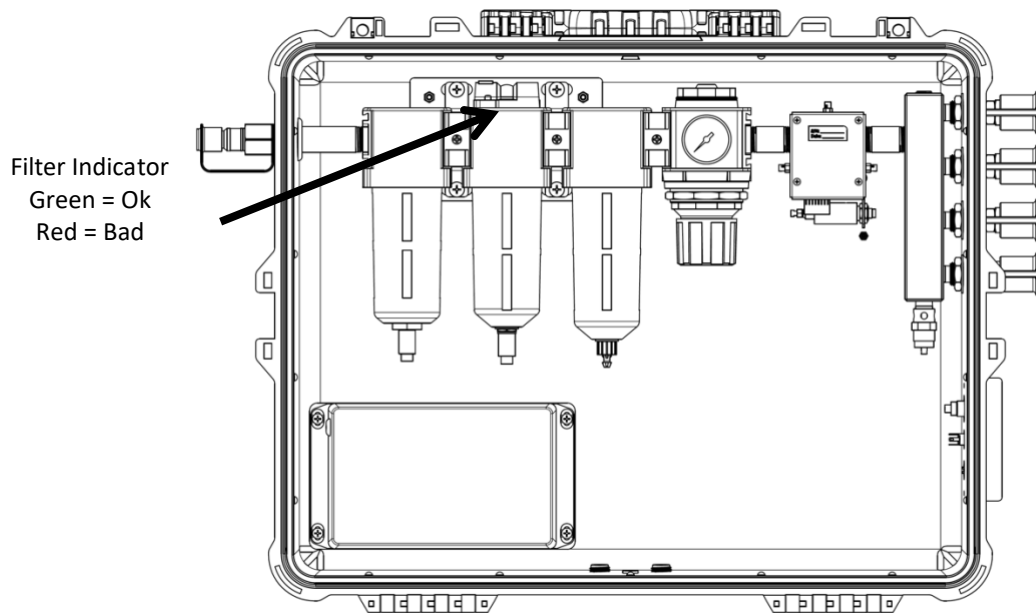

## General Filter and Sample Train Parts

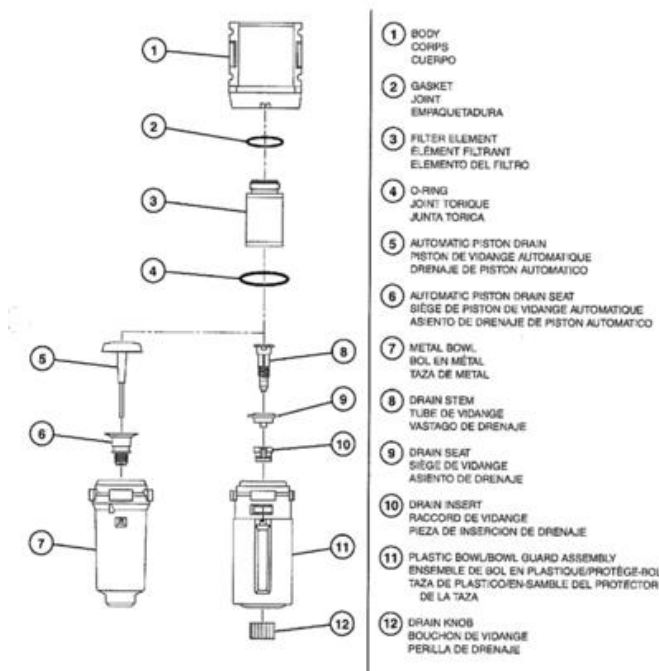

The replacement filters can be ordered using the following part numbers:

<u>AirGuard</u>	<u>Part Number</u>
15 CFM	AGD15FK
30 CFM	AGD30FK
50 CFM	AGD50AND100FK
100 CFM	AGD50AND100FK

Position A - 5 Micron Filter.  
 Position B - 0.01 Micron Coalescing  
 Position C - Charcoal Adsorption Filter

The filter bowls are attached to the air flow sample train using a 1/3 or 120° rotation twist.

To remove the filter from the air train, push the filter bowl up and in towards the sample train gas flow and twist counter clockwise and then pull down. That will expose the filter component.

The filter can be removed by rotating it counter clockwise until released from the main filter train assembly.

Repeat this process for all three of the sample filters.

---

AirGuard Parts

AirGuard Part Description	Part Number
15CFM Replacement Filter Kit	AGD15FK
30CFM Replacement Filter Kit	AGD30FK
100CFM Replacement Filter Kit	AGD50 and 100FK
Battery Assembly	AGDBAT
CO Sensor	AGDCOS
Regulator Assy (CGA600)	AGDREGTB
AirGuard Calibration Kit	AGDCK
LCD Clear Overlay (Pk 5)	AGDLC
AirGuard 15 CFM	AGD15HA
AirGuard 30 CFM	AGD30HA
AirGuard 50 CFM	AGD50HA
AirGuard 100 CFM	AGD100HA

Notes: